

## A GENERAL OVERVIEW OF TRIBOLOGY OF SHEET METAL FORMING

Miklós Tisza - Tibor Fülöp  
University of Miskolc, Department of Mechanical Engineering, Miskolc, Hungary  
H3515 Miskolc – Egyetemváros

### ABSTRACT

*Deep drawing operation is a complex process, containing different interacting components, influenced by several parameters. These parameters can be divided into several groups: the press, die and part design, materials and lubricants applied during the operation. Furthermore, the interactions between these components are very difficult to evaluate. Experimental systems for mechanical characterisation of sheet metal properties are available: the elastic and plastic material parameters in large range of temperature can be measured. However, the automation of lubricant performance evaluation is a future challenge in the sheet metal forming, and system development. One important problem concerning the system development is the interaction between surface parameters and lubricants, which is not quite clearly known until now. Further difficulties are due to the lubricant selection process itself. Firstly, the use of mineral oils has become increasingly questioned in many fields of application. The growing environmental, health and safety awareness has caused rapidly growing interest for environmental friendly oils (vegetable and synthetic) as a base for lubricants in metalworking, as well. On the other hand, the cost reduction requires the reduction of relative cost, and the quantity of lubricant, too. This may improve the conditions for part cleaning after forming.*

### 1. INTRODUCTION

The effect of friction can be one of the decisive factors in metal forming, and this is particularly true in sheet metal forming. If plastic deformation is mainly localised in one direction and the tool does not act as process motor – as in the deep drawing – the friction is harmful. It can cause the increase of forming forces, tool wear, and surface defect of product. On the other hand, when at least one of the tools act as motor during the process – like in rolling – the friction is required to be higher than a certain limit and low enough not to cause defects.

---

The theoretical analysis is generally a complex task. In three-dimensional deformations – as sheet metal stamping – the value of friction is dependent on time, on the location in the surface and on the geometry. It is additionally influenced by the tool - working piece contact, the surface state, the presence of the actual lubrication, even on the deformation rate and the local temperature.

However, it is very important for the successful technological design to characterise the friction state as much as possible. The main parameters, which should be included in such analysis, are as follows.

Basically, the final quality of the part surface will significantly depend on the friction, if the surface area is in contact with the tool somewhere during the operation, and the most deformed section will be the most damaged, as well.

To characterise this contact, it is important to observe the *surface quality* and to characterise its roughness, hardness and chemical composition, both for sheet and tool materials. A further aspect is the *evolution of different properties* during the plastic deformation, or during the temperature changes, introduced by the plasticity itself, or resulted by a heat treatment. The *wearing properties* should be determined to predict the rupture or adhesion phenomena. These are mainly dependent on the thermomechanical and chemical properties of the connected surfaces. Other parameter during the process is the presence - or lack - of *lubrication*. It is in interaction with the surface quality, and several optimisation steps could be performed to increase its effect. As an example, the surface treatment of tools can be mentioned: it can decrease the friction and the tool wear, mutually.

Thus finally, three different facts should be considered: the deformation introduced during the process (mechanical problem); the surface structures of the adjacent bodies - sheet and tool - (chemical problem) and the surface quality of the contacting surfaces (tribology). However, actually there is no common description of these effects. In order to prepare a unified theory, or even to develop a computer aided method for lubricant selection, the existing tools should be organised into a unified system. The aim of the present study is to review the state of arts of sheet metal characterisation. Two main scales will be considered.

### 1.1. Macroscopical approach of contact

In first approximation, the material-tool contact in sheet metal forming can be characterised with the following facts:

- The contact present between the tool and the material results in a high contact pressure (sometimes up to 1 GPa);
- The contact is extremely asymmetric: elastic on one side and plastic – or even viscoplastic – on the other.

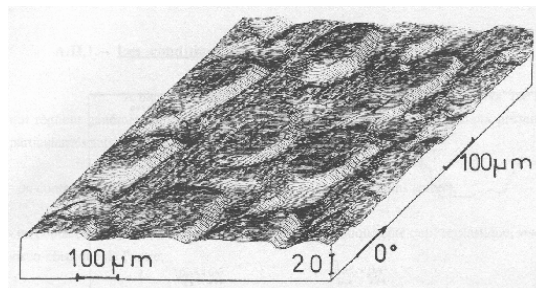

Figure 1 - Surface topology of a sheet produced by cold rolling [1]

- The contact surface has complex shape and it is dynamically changing.
- Additionally, it is very difficult, in some cases practically impossible to get experimental value for the different contact parameters. This underlines the role of modeling.

In Figure 1, an example of a surface topology is presented. The image, prepared by special scanning instrument, shows well the complexity of the surface structure of a sheet metal, subjected to normal forming operations. It is important to mention the regular shapes present on the surface, arising from the forming process.

This modelling of contact is generally performed on the basis of classical continuum mechanics. The basic assumption is the following: the condition of contact is influenced primarily by the two deformed bodies in contact. For sheets, the calculations are made by using the theory of plasticity. However, due to the complexity of the phenomena, the theoretical description could only approximate the real effect, calculating the shear stress only in function of a unique parameter. Generally, three different theoretical expressions are used in metal forming: the Coulomb, the Tresca and the Norton law. Each of them is isotropic. They differ in the deformation mode considered. As the last two takes into account the effect of time, they are particularly important for viscoplastic deformation. In sheet metal forming the Coulomb law is widely used. In general, it can be written in the following form:

$$\tau = -\mu\sigma_n \frac{\Delta\bar{v}}{\Delta v}, \quad (1)$$

where  $\sigma_n$  is the contact pressure,  $\Delta\bar{v}$  is the speed of slip and  $\mu$  is the Coulomb friction parameter.

A more complex macroscopical approach may be completed by including the thermal effects. As in conventional sheet metal forming the temperature changes can be neglected, in the following it will not be considered.

### **1.2. Microscopical approach of contact**

During microscopic investigations, due to the surface roughness of sheet and tool a third body, the lubricant should be taken into consideration.

If the sheet and the tool are in direct contact, their relative movement will produce a plastic deformation on the sheet surface – as the tool is supposed to be elastic. If the tool surface is clean, it tends to deform the sheet surface. If it is rough, it will streak the sheet. The limiting case is the milling: the part surface will be deformed by small abrasive particles. Other important cases are the contact between the sheet and the lubricant: lubrication by presence of a thick or thin lubricant film.

Thus, in the first case, when the *lubricant film is thick*, the problem to be solved is a coupling between plasticity and hydrodynamics. The friction law can be directly studied, as the contact is displaced from the original surfaces into the film itself. The applied numerical methods are able to analyse the complex behaviour of the lubricant film, and the prediction of shear stress present in this film. While this problem is complex – dependent on the temperature and on its gradient as well, a relatively simple function can be elaborated.

The other case is the domain of *thin lubricant film*. This is a transition region between the dry friction (direct tool - metal contact) and the region of complete lubrication (thick lubrication film). Additionally, several new effects should be considered, as chemical reactions between different oxides and the lubricant. A decisive aspect is the reaction between the base metal and the lubricants, giving a real diversity of contacts.

### 1.3. Lubrication in sheet metal forming

Sheet metal forming processes are too complex to clearly separate the different influencing effects. Thus, tribological properties, and frictional processes are just two of several factors determining the result of forming. Recent studies have been focused on the determination of the importance of different parameters on the success of a given technology. During these investigations, different car manufacturers have been interviewed, in order to list and rate the main factors, present in the industrial practice, Figure 2.

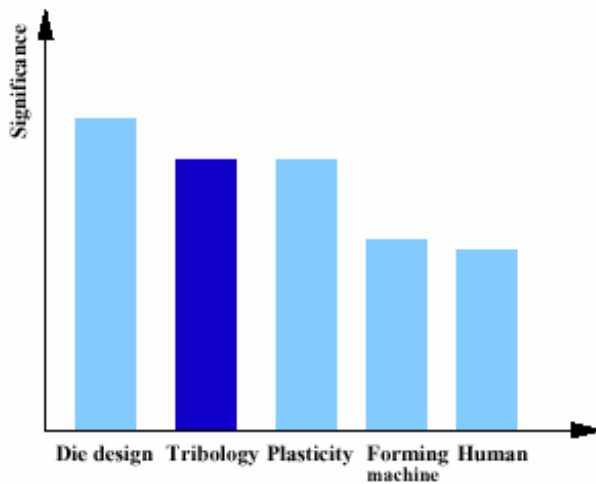

Figure 2 - Relative importance of some parameters in sheet metal forming [2]

As it becomes clear, the tribology of sheet metal forming is one of the main influencing parameters. Additionally, its interaction with other constraints is also important, for example in most cases the human factor should be taken into account.

From other analysis, one may conclude, that the tribology itself consists of the interaction of different factors connected to the sheet metal surface. Generally, the term “surface” comprises not only the boundary layer of the volume material, but also its structure. The geometry of surfaces is called topography and it is generally subdivided into shape, waviness and roughness.

In addition to topography, the mechanical and chemical properties of the boundary layer should be also considered, as there can be found different sub-layers influencing the joining capabilities, the adhesion of paint or the corrosion protection. Finally, the base material should also be considered in studying sheet metal surfaces, as the deformation can change the surface structure by forming new surfaces, etc.

At the same time, the tribological properties could not be simply optimised for manufacturing processes. During annealing after cold rolling in sheet manufacturing, the stick of individual plies of material should be avoided, with surface lubrication. After rolling, the sheet metal surface should be prevented from rust formation during transport and storage before further processing. For this purpose, the surface should be coated with corrosion protection oil. Following the transport, during manufacturing, if the plates are stacked, an inappropriate surface can cause the

---

plates to stick together so that several plates are simultaneously placed into the press in an automated process. After forming, the lubricant should be generally removed, and additional surface treatment, e.g. painting should be applied, to protect the product from corrosion. However, additional manufacturing steps, as welding should be possible as well.

These different requirements cannot be met to equal extent by surface treatments, and frequently, compromises should be made between conflicting requests. For instance, topography optimised under tribological aspects should have large craters to accommodate lubricant. However, this contradicts the requirement for a fine structure of maximum smoothness to allow top quality painting. For good lubrication, the sheet metal surface is required to have high wetting capacity to retain the lubricant within the forming zone. This is in conflict with the requirement that the lubricant should be easily removed before the component is painted.

This points underlines the importance of the optimisation process in sheet metal industry. However, this optimisation requires the knowledge of different rheological and tribological parameters, and the correct characterisation of the sheet topology. In the next section, the possibility to get these parameters will be shortly reviewed.

## **2. FRICTION TESTS**

The principal objective of the friction tests is the determination of a unique or tensor friction coefficient, which can be used during the process planning of the sheet metal forming. According to the theory of friction, these tests could not be general: due to the great number of influencing parameters, several simplifications should be made. Corresponding to these simplifications, the existing tests may be divided in two main groups: so-called classical (general) tests and the technological tests. These tests generally can be further grouped based on different friction laws. They provide method to determine the shear stress present at the surface, and applied practically in theoretical tribology.

### **2.1. Classical tests**

Several methods can be found in this group. Based on the theoretical friction law presented in the previous section, several works were focused on the measurement of theoretical friction coefficient introduced. As these friction laws were heavily simplified, the first tests were only dependent on part geometry, and were only used to determine the effect of various external parameters - materials, lubricants, tool materials, etc. Principally, different tests were developed for sheets and bulk materials, or general testing methods were proposed. In this part, two methods will be presented, used generally for sheet metal geometry: the hardness test (indentation test) and the modified Watts-Ford test.

#### **2.1.1. Hardness test**

This test is one of the most widely applied mechanical tests. Generally, it is applied to measure the hardness of the part. Yet, the same methodology can be implemented as a way to determine the friction coefficient. The hardness calculation is based on the measurement of the indenter load  $P$  and the traces of the indenter tip in the tested metal. As the force is normal on the part surface, the pressure under the indenter tip can be calculated. The indentation process can be

analysed as a normal bulk metal forming process, dependent on the materials and on the interface friction effects.

The success of the normal hardness measurement is highly dependent on the tool-indenter geometry and on the material. Its shape can be conical - in case of Rockwell C method, spherical - for Brinell or Rockwell A methods, or pyramidal - for Vickers. During the test, the indentation depth or the size of the indenter trace can be measured. The load  $P$  can be varied in wide range, so very thin layers can also be examined by several micro methods. Unfortunately, due to the complexity of the process, the exact pressure can only be approximately determined. As an advantage of this method to characterise the friction is the application of a general, widely available tool, i.e. the hardness test. Additionally, it provides a local friction value. As feedback, the heavy dependence on the indenter geometry and the difficulties connected to the determination of pressure - friction relationship should be noted.

### 2.1.2. Modified Watts-Ford test

The compression of a large, flat part ( $L \gg 2a \gg h$ ) by external  $\tau$  shear stress require the  $p$  mean contact pressure, with the notations of Figure 3:

$$p = 2k + \tau a/h. \quad (2)$$

While during real tests, in practice, a small change of the width can be observed, it is very small, and the parameter determination based on this test is simple. In the test, the final sheet thickness  $h_f$  and the applied  $F$  force can be measured. As the  $k$  rheological parameter of the sheet is known, the friction shear stress can be calculated.

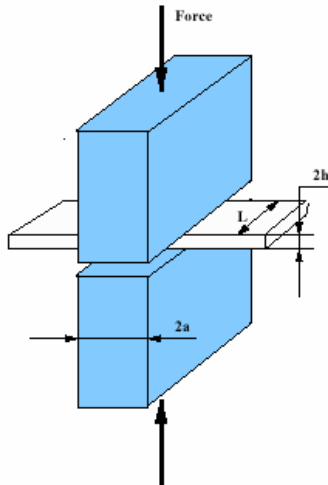

A further advantage of this method is that it makes even possible to determine simultaneously the rheological and tribological parameters, by a series of tests, performed in similar lubrication state. If the  $h_f$  is fixed, from the evolution of  $p$  the  $\tau$  shear stress can be calculated, which gives the value of  $k$  for  $\varepsilon = (2/\sqrt{3})\ln(h/h_0)$ , defined total deformation -, according to the original proposal of Watts and Ford.

This test, as it is evident from geometrical considerations, can be well adapted for sheet parts, and for corresponding technologies, as deep drawing, ironing or rolling.

## 2.2. Technological model tests

According to recent investigations, the choice of the laboratory tests has vital influence on the result of tribological investigations. As the previously presented general test provides only theoretical approximation of the real processes, they can not be used for special lubricant characterisation. From this reason, the tribology in sheet metal forming has two directions: one aims at understanding the basic phenomena, the other attempts to study the influence of variables in the actual deformation process, based on different simulation tests. Occasionally, these simulation tests can also be used for basic studies, however, they must satisfy several criteria.

These are as follows: 1) the deformation mode, thus the change of the surface topography of the sheet should be the same. 2) The tooling must have the same composition and surface topography, as the press die. 3) The test should operate in the same lubrication system, as the real technology.

According to these requirements, for different deep drawing processes, different methods were elaborated. The most important processes are the following.

### 2.2.1. *Stretch forming*

In pure stretch forming, the sheet is totally clamped and is deformed by a punch. The deformation, the lubricant film development, and thus the lubrication system is highly complex. This deformation mode is present on the punch radii during a complex sheet metal stamping operation.

The simplest simulation test involves a reduced-scale test, such as the Olsen cup test and the Erichsen cup test. These tests stretch a specimen over a hardened steel ball until fracture, and the height of the cup is measured. In the Olsen cup test, a 22 mm diameter ball-end punch and a 25.4 mm die throat diameter are used for sheets below 1.6 mm. The die radius is 0.81 mm.

Many parts are formed by stretching over a punch with radius edge. This is simulated by drawing a strip around rollers in a constant direction or by wrapping. From measured extension, the friction force and the friction coefficient can be calculated. However, the test creates an entry wedge, which is absent in the production process. This will surely change the lubricant film thickness with unknown consequences.

### 2.2.2. *Deep drawing*

The part is formed by drawing the sheet into the die, and the aim of lubrication is to facilitate this draw-in. The conditions are complex, and subject to gradual changes. With the beginning of draw, contact zones are developing at the punch face, and squeeze film develops. The contact place is constantly changes, and the lubrication system is different at various sheet points.

The most commonly used test for deep drawability is the *Swift cup test*. The blank is drawn to the maximum punch load that occurs before the cup is fully drawn. The serrated clamping ring then clamps the flange that remains in the blankholder, and the punch stroke is restarted until the maximum load occurs again and the cup will be broken. The punch diameter is 50 mm, and a die throat of 52.2 mm is used - Figure 3.

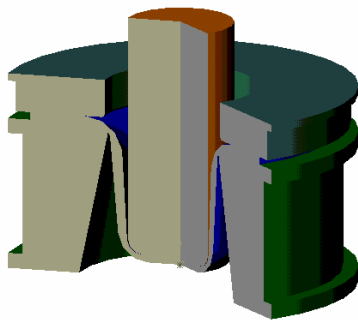

Figure 3-Tooling system for Swift čůp test - and the corresponding model tests [3]

Simulation tests attempt to circumvent complexity by concentrating on individual zones. Bending under tension tests aim to simulate the straight-side zone of rectangular pans. The strip is drawn over a pin while applying back tension. From tests with rotating and fixed pins, the frictional force can be calculated, and the effect of lubricants, tool surface, sheet material changes can be investigated. Unfortunately, the accuracy of the test should be verified.

Simulation of the blank-holder zone seems to be simpler. Sliding the sheet between parallel dies is very popular method of sheet testing. However, the correlation with deep drawing is relatively poor. Several reasons can be cited: the axial compression is non-modelled, and the effect of die radius is not taken into account. These drawback could be reduced by more sophisticated tooling, but obviously, this may lead to more complex simulation.

A further important problem with these simulation tests is that they neglect the elastic effects, leading to geometry changes and possibly, the development of unstable lubrication zones.

### 2.2.3. *Stretch drawing*

The success in combined stretch forming and deep drawing depends on the controlling of the flow into the die: excessive restraints lead to fracture, insufficient restraint to wrinkling. For adequate control, the force required for bending and unbending a sheet over one or more drawbead is employed. It is shown in Figure 4.

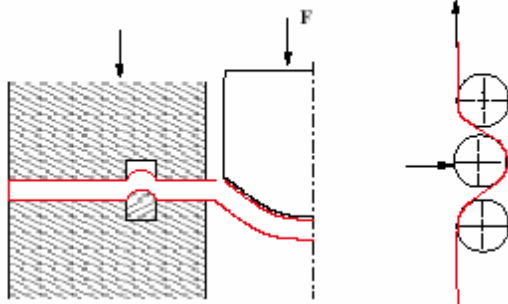

Figure 4- Tooling system for Inland drawing test [6]

One of the most direct simulation of the process is the Nine's drawbead simulation. From the draw force determined with freely rotating cylinders, a nominal coefficient of friction can be calculated after taking a number of simplified approximations. The test geometry can be very close to the actual die geometry, and the result correlates well with actual industrial experiences.

In practice, drawbead may have different geometry, making very difficult the elaboration of unified test equipment. Simulation is obviously possible, but the evaluation is generally limited to measuring forces and observing die pickup. Extraction of the frictional force is difficult and requires theoretical development.

### 2.2.4. *Summary*

All tests reviewed here allow studies of some basic phenomena and thus qualify as benchmark tests. The actual question of the current research is the transferability of the results to the practice. Standardisation of these tests has also vital importance in engineering practice. The actual effort of international research community is focused on these questions.

## 3. TOPOLOGY OF SHEET SURFACE

After cold rolling, the sheet material is annealed in order to restore the forming properties for deep drawing. To prevent the plies of the coils from sticking after annealing, the final pair of rolls in the cold rolling mill can be roughened [4]. During rolling, the roughness profile of the rolls is imprinted on the sheet material. After annealing, the material has a distinct yield point, which can cause flow patterns in subsequent forming. These effects can be avoided by rolling the



material in the skin-pass mill stand. Simultaneously, rerolling is also used for producing the final surface roughness. The structure of the skin-pass rolls is superimposed on that applied by cold rolling.

For roughening the rolls to prepare a distinct surface topography, there are several methods currently available. Grinding is still being used on rolls for aluminium but will be replaced increasingly by other processes, listed in the next section.

### 3.1. Shot Blast Texturing (SBT)

In Shot Blast Texturing (SBT), sharp-edged blast material is thrown on the roll from a centrifugal wheel. When hitting the roll surface, the blast grain causes plastic deformation and severs particles from the surface. The roughness of the roll can be varied via the speed of the centrifugal wheel, the blast material used, the hardness of the roll, the throughput of blast material and the period of treatment. The resulting surface texture is highly stochastic, but isotropic.

### 3.2. Electron Beam Texturing (EBT)

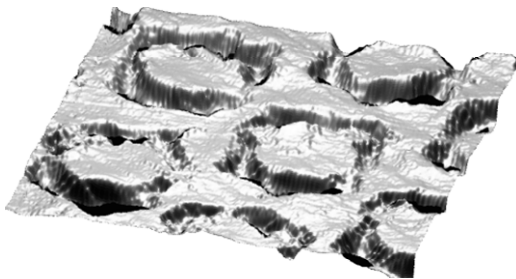

Figure 5 - Surface trace of EBT roll on the sheet

Electron Beam Texturing (EBT) applies an electron beam for melting the roll. Part of the molten metal is vaporised so that the vapour pressure piles up the molten metal as a ring around the crater. The roll is rotated and axially moved in a vacuum chamber. It is possible to synchronise the rotation of the roll with the shooting frequency to have uniformly distributed craters in all directions. As in laser texturing, the craters can overlap to such an extent that the regular structure is no longer noticeable. These surfaces are called pseudo-stochastic. The general view of the surface can be seen in Figure 5.

### 3.3. Electrical Discharge Texturing (EDT)

In Electrical Discharge Texturing (EDT), electrodes are moved in radial direction, to the rotating roll surface and are oscillated in axial direction. Due to the discharge pulse, the particles within the dielectric between roll and electrode form a dipole bridge causing a current to flow. A small area of the roll surface is molten, and a gas bubble forms in the dielectric. When the pulse is shut off, this gas bubble implodes and the molten roll material is ejected. The roughness can be varied regardless of roll hardness via voltage, control cycles and electrode distance. As compared with SBT, EDT allows higher numbers of peaks, and lower roughness values can be obtained at higher repeatability.

### 3.4. Laser Texturing (LT)

In Laser Texturing (LT), a laser beam is focused on the roll, melting a small area of its. A chopper wheel interrupts the beam, and the molten metal is blown out by plasma pressure and an inert gas. In this event, the molten metal either builds up in a bulge around the rim of the crater or

is accumulated on one side of the crater where it solidifies. The roll is rotated and slowly moved in axial direction. Roughness can be changed by laser power, axial motion, roll and chopper wheel speed as well as the inert gas.

*Table 1 - Comparing the texturing methods [1]*

<i>Method</i>	<i>SBT</i>	<i>EDT</i>	<i>LT</i>	<i>EBT</i>
Regularity	stochastic	Stochastic	(semi-) deterministic	deterministic
Roughness of rolls	Ra 1-6	Ra 0,8-10	Ra 0,8 - 10	crater diam. 90-530
Peak count (PC)	low - medium	High	low, up to high for pseudostochastic	medium, up to high for pseudostochastic
Relation PC/Ra	clearly related	PC related to Ra	PC little related to Ra	PC little related to Ra
structure transfer dry rolling	limited	good	distinctly reduced	good
structure transfer wet rolling	reduced	Reduced	essentially reduced	essentially reduced
reproducibility	bad	good	good	good

### 3.5. Summary

The topology of the sheet surface is highly dependent on its manufacturing method. Due to the different tool preparation for sheet rolling, a very complex surface design can become possible. This will theoretically allows choosing the best sheet material for a given process.

Unfortunately, indication of the method by which a sheet metal surface has been generated is not sufficient for proper description of its function. Just as zinc coatings can vary within a single manufacturing method, also the topographies from a dressing process can be distinctly different in functional behaviour. To describe a surface unambiguously, further process parameters should be specified for each manufacturing method. This is why a direct comparison of dressing processes is very difficult. In Table 1, some parameters concerning the roughness properties are compared.

Further difficulties are caused by the variation of the pattern on the rolled sheet surface. The roll preparation method does not indicate the pattern itself. For example, in case of EBT method, different topography can be obtained, simply by varying the shape and the mean roughness of the role pattern. This is the reason of researches for further classification of topographies given in the following section.

## 4. CLASSIFICATION OF TOPOGRAPHIES

The aim of surface measuring in sheet metal forming is the practical description of the topographies by means of consistent parameters. In practice, many surface parameters can be calculated. In order to restrict this number reasonably, the choice of parameters should be based on their possible application. For assessment of the tribological properties, it is necessary to have model notions of the tribological mechanisms. Based on these mechanisms it is necessary to

---

consider which geometrical properties of the topography can influence these mechanisms. From this, parameters can be derived which allow quantification of the function-relevant mechanisms.

In the literature, several attempts have been made to elaborate such systems [1,4,5-7]. They are connected to the lubrication mechanisms, and classify the sheet topography by the obtained forming conditions.

#### 4.1. Classification of geometrical properties [2]

Generally, surfaces having a high material ratio already at low penetration are qualified as *closed*, while surfaces having a low material ratio at the same penetration are called *open*. Figure 6 illustrates open and a closed model surface according to the above definition.

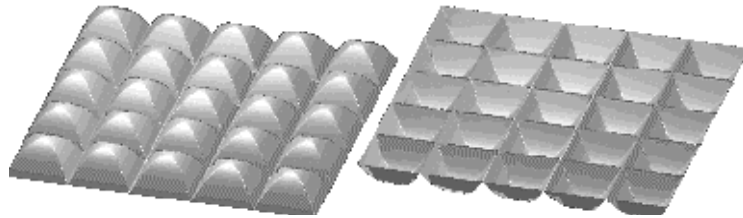

Figure 6 - Open and closed surfaces

The terms closed and open are used to denote confinement. According to this definition, the right-hand surface in Figure 6 is closed since it has closed lubricant pockets. The left-hand surface is open because the lubricant can escape from the topography.

It is evident, that in order to avoid misunderstandings in the assessment of topographies, an unambiguous definition of terms is indispensable. A possible classification, proposed in [2] and [4] is the following. A property of a topography is described by a feature and its value: *property* = *feature* + *value*. A topography is characterised by the sum of its properties. A selection of features is listed in Table 2.

Confinement describes whether the “passes” of the topography is high or low. The right-hand surface in Figure 6 is closed, the left-hand one is open. As a surface parameter describing confinement, percolation depth can be used. This indicates the penetration up to which continuous void areas are present, enabling a connection from one side of the measured area to the other. This feature is called void. Topography having a high material ratio is called full, one having a low ratio is called empty.

*Table 2 - Features and values of topographies*

	<i>Feature</i>	<i>High Value</i>	<i>Low Value</i>
1	CONFINEMENT	closed	open
2	VOID	void	full
3	FINESSES	fine	coarse
4	DENSITY	dense	wide
6	Regularity	stochastic	deterministic
7	DIRECTION	anisotropic	isotropic
8	WAVINESS	wavy	flat

Fineness and density are closely related. Topography is called fine when it consists of a lot of peaks or valleys. Density describes how closely the various structure elements are packed. For some structures, it is necessary to distinguish between fineness and density since widely spaced large craters can form a fine structure if the craters overlap. In deterministic topographies, the structure elements are repeated in certain directions in space at regular intervals. Topography made by EBT has deterministic hexagonal crater arrangement. Ground surfaces, as well as surfaces produced by SBT or EDT methods are regarded as stochastic structures.

Topography is anisotropic when it has different properties in different directions. Ground surfaces are anisotropic. When the influence of slip during rolling is neglected, then surfaces produced by SBT or EDT methods are isotropic. Deterministic structures are invariably anisotropic because they have different crater intervals in different directions.

#### **4.2. Classification following the utilisation**

To distinguish tribological behaviour of topographies, the tribological mechanisms can be used. Some topography can be smoothed during the forming process, thus hydrostatically active lubricant pockets are produced. In open topographies (low passes), the lubricant can escape laterally even if the topography has been smoothed to a significant extent, while on closed topographies confined lubricant pockets develop at a low degree of smoothing already. The effect of the void character of the topography depends on how distinctly the lubricant pockets are distributed. In a full topography, only a small proportion of hydrostatically bearing lubricant pockets can develop in spite of the high degree of confinement since the confined lubricant pockets make up just a small proportion of the contact surface. In order to reach a high maximum confined void area ratio, the surface should be confined and empty

On other topographies, an increase of slip speed causes a distinct decrease of the friction coefficient. This phenomenon cannot be explained by hydrostatic effects, but by hydrodynamic ones only. It can be observed in strip drawing tests that using lubricants having higher viscosity at

low contact normal pressures, there is a separation between tool and sheet metal to such an extent that only few peaks of the topography come into contact with the tool.

For higher surface pressures, plasto- and elasto-hydrodynamic effects can be observed through transparent tools. A small amount of lubricant is pressed from a lubricant pocket into the contact surface by hydrostatic and hydrodynamic effects. In this lubricant film having a thickness of fractions of a  $\mu\text{m}$ , high pressures can occur, thus reducing friction. In case of appropriately thin lubricant films, pressures required for plasto-hydrodynamics above the yield point of steel can be reached.

Another hydrodynamic effect can be observed when the blankholder is seated on the sheet, displacing the lubricant laterally. The more lubricant is displaced, the greater is the resistance to be overcome for displacing the remaining lubricant. In the case of ideally smooth tool and material surfaces, the tool will never contact the material. On rough surfaces, displacement of the lubricant ends when the contact normal pressure is completely borne by the actual contact surface and by the pressure in confined lubricant pockets. The time required for this smoothing action at a given contact normal pressure on actual deep-drawing parts, depend on the size of the area under load, the viscosity of the lubricant and the topography. In open empty topographies, the lubricant can escape from the contact zone through the low and wide channels faster than in closed full topographies.

In complex deep-drawing parts, all mechanisms are active simultaneously. The share contributed by a mechanism to the reduction of friction depends on the topography, its modification and the local stress conditions being subject to change over time and location. It is therefore not possible to specify a topography that would be optimal for all tribological requirements. Assessment as to which mechanisms offer favourable conditions should be made on the component to be produced. Subsequently, appropriate topographies can be chosen to support these mechanisms. In Table 3, it is attempted to specify the required conditions for the mechanisms described and to define the properties of appropriate topographies.

*Table 3 - Different lubrication schemes and the topography [2]*

<i>mechanism</i>	<i>hydrostatically acting lubricant pockets</i>	<i>hydro-dynamically acting flank</i>	<i>elasto-/ plasto-hydro-dynamically acting step</i>	<i>squeeze flow</i>	<i>macroscopic lubrication pockets</i>
Favorable conditions	• distinct flattening of	• low contact pressure	• flattening of peaks	• quick forming	• appropriate geometry

	<ul style="list-style-type: none"> <li>topography</li> <li>high contact pressure</li> <li>straining of the sheet</li> <li>friction stress in peaks of topography</li> </ul>	<ul style="list-style-type: none"> <li>high viscosity lubricant</li> <li>high sliding velocity</li> </ul>	<ul style="list-style-type: none"> <li>high contact pressure</li> <li>straining of the sheet</li> <li>high viscosity lubricant</li> <li>high sliding velocity</li> </ul>	<ul style="list-style-type: none"> <li>large homogeneously loaded areas in the die</li> <li>high viscosity lubricant</li> </ul>	of the die
Favorable topography	<ul style="list-style-type: none"> <li>closed void</li> <li>no large peaks</li> </ul>	<ul style="list-style-type: none"> <li>full plateaus barely inclined</li> </ul>	<ul style="list-style-type: none"> <li>full flat plateaus</li> </ul>	<ul style="list-style-type: none"> <li>void</li> <li>closed</li> </ul>	<ul style="list-style-type: none"> <li>closed</li> </ul>

## 5. CONCLUSIONS

Following the previous considerations, it is evident, that in sheet metal forming, the term “surface” comprises besides the shape constituting the boundary between sheet material and the environment the structure of the boundary layer. The geometry of surfaces is called topography and can be subdivided into *shape, waviness and roughness*. In addition to topography, the mechanical and chemical properties of the boundary layer should be also considered. They exert an influence on the tribological behaviour and on the changes of the surface during the forming process.

Based on various combinations of base materials, topographies and coatings, very large variations of surfaces with extremely differing properties are available in sheet metal forming. For application of topographies on the sheet material, several methods can be used for roughening the final roll, and during rolling, the structure of the rolls is imprinted on the sheet material.

For corrosion protection, in automotive industry sheet metal is frequently coated with zinc layer. With the proper selection of process parameters, the zinc coating processes provide a wide range to modify the properties of the coatings: hardness, structure and chemical composition of these coatings can be fitted to the applications.

The fact that through its geometrical, mechanical and chemical properties the surface can exert high influences on the forming result is known from experience and from various results of research. An actual direction is the development of classification methods for sheet surface topographies.

Other important point concerning the friction effect is the *need of standardised friction tests*. The current test development is connected to the fact, that the “best friction law” for sheet metal forming could not be defined. Additionally, due to the complexity of the drawing process, no unique lubrication mechanism can be distinguished, thus obviously no best lubricant can be simply defined. It emphasises the necessity of the development of different tests for different forming processes: stretch forming, drawing on radii or on punch surface.

Following the previously presented considerations, several research directions can be distinguished: development of theoretical friction law in order to take into account the different parameters present during the forming process; development of sheet surface classification methods; development of experimental friction tests. These research fields are in strong interaction

---

in order to permit the use of the best fitted friction law with consistent parameter values in numerical codes or theoretical calculations.

### *Acknowledgement*

This research project was co-financed by the European Union, in the framework of a Joint European Project entitled *Enform* (ERB IC15-CT-98-0824) which is gratefully acknowledged.

## **6. REFERENCES**

- [1] *Séminaire de Plasticité*, organized by J-L Chenot, École des Mines de Paris, CEMEF, Sophia Antipolis, 1994
- [2] STAEVES, FITZEK, SCHMOECKEL, Surface qualification in sheet metal domain, Darmstadt University of Technology, <http://www.ptu.tu-darmstadt.de/forschung/tribologies/sheetmet> 2001
- [3] Hassan Rowshan, Ms.C. Thesis, University of Miskolc, Department of Mechanical Engineering, 2000
- [4] SCHMOECKEL, STAEVES, Determination of minimum quantity of lubricants, Darmstadt University of Technology, <http://www.ptu.tu-darmstadt.de/forschung/tribologies/ictmp> 2001
- [5] Engelman D., Ph.D. Thesis, Technical University of Budapest, 2001
- [6] Delamare, Kubié, Montmitonnet, Influence de la microgéométrie de la tôle., École des Mines de Paris, CEMEF, Sophia Antipolis, 1980
- [7] Schey, The applicability of tribotester to sheet metalworking, IDDRG Working Group Meeting, Colmar, France, 1995
- [8] Anderson, Gjonnes, Berg, Characterisation of the Surface Topography of Al Sheets, IDDRG Working Group Meeting, Colmar, France, 1995
- [9] Montmitonnet, Friction laws and plastic deformation, Journal de Mécanique, Paris, 1992
- [10] Wihlborg, Crafoord, Frictional study of uncoated steel sheets, Advanced Technology of Plasticity, Vol.1., Springer, 1999.

## OPŠTI PREGLED TRIBOLOŠKIH PROBLEMA U OBRADI LIMA

*Miklós Tisza, Tibor Fülö*

### REZIME

*Duboko izvlačenje je kompleksan proces koji se sastoji iz različitih interaktivnih komponenti koje su pod različitim uticajima. Uticajni parametri mogu se podeliti u nekoliko grupa: presa, alat i radni komad, materijal (lim), mazivno sredstvo. Pored toga međudejstva između pojedinih gore navedenih parametara vrlo je teško precizno odrediti. Za mehaničko ocenjivanje lima postoje razvijene eksperimentalne metode i sistemi, tj. mogu se meriti elastični i plastični parametri u širokim rasponima temperature. Ali, automatizacija ocene mazivnog sredstva u domenu obrade lima je još uvek veliki izazov.*

*Važan problem koji je vezan za razvoj sistema za automatizovanu ocenu je međudejstvo između parametara površine i sredstva za podmazivanje. Ovo međudejstvo do sada nije u potpunosti determinisano. Teškoće postoje i u samom izboru maziva; korišćenje mineralnih ulja se u mnogim oblastima sve više stavlja u drugi plan i to, pre svega, zbog intenzivnih napora za zaštitu čovekove okoline. Enviromentalistička svest sve više utiče na to da se koriste tzv. "friendly oil" ("prijateljska ulja") – biljna ili sintetička kao baza za mazivna sredstva u obradi deformisanjem. Sa druge strane zahteva se i smanjenje kvantiteta mazivnog sredstva, što dovodi do poboljšanja uslova čišćenja radnog komada nakon obrade plastičnim deformisanjem.*