



Original article

The Stress Strain Analysis of Forward Extrusion Process of Hollow Elements

Saša Randelović^{1*}, Nikola Vitković¹, Vladislav Blagojević¹, Marina Trajković Milenković²,
Andrija Zorić², Nikola Kostić¹

¹University of Niš, Faculty of Mechanical Engineering, 18000 Niš, Serbia

²University of Niš, Faculty of Civil and Architecture Engineering, 18000 Niš, Serbia

ABSTRACT

This paper presents an analysis focused on the stress-strain dynamics within the forward extrusion process for hollow elements. The forward extrusion of hollow elements is characterized by extensive plastic deformation and complex material flow. This process involves splitting the metal continuum, subjecting it to plastic deformation, and merging it into a seamless product with a predetermined cross-sectional shape as it exits the tool. Employing modern numerical finite element methods is essential for designing such processes, as it enables the simulation of metal behavior within the tool. These simulations help predict mechanical parameters within the deformable material continuum, such as stress, strain, temperatures, and strain rates. Additionally, they allow for the optimization of tool designs tailored to the specific product, improving process efficiency and quality. Understanding the stress-strain distribution at individual nodes enables proactive measures to prevent mechanical disruptions within the continuum, ensuring the integrity and quality of the final product—an essential criterion in the forward extrusion process for hollow elements.

Key words: Extrusion, FEM, Stress, Strain, Deformation velocity, Tool, Profile

1. INTRODUCTION

Modeling the process of forward extrusion of hollow elements using Finite Element Method (FEM) presents a challenging task that is frequently handled utilizing modern software solutions. This procedure encompasses two main aspects: one focusing on the properties of the materials being extruded, while the other concentrates on developing the tooling. However, the process becomes notably meaningful when a unified software simulation integrates these diverse elements. [1].

To model the extrusion process with the FEM, three formulations can be used. The transient updated Lagrangian formulation, where the FEM mesh is attached to the

deforming billet, is able to capture the material flow in a very intuitive way [2]. Runtimes can be long, but this method can produce some results that are difficult or impossible to obtain from other simulation methods. Some available results include: material splitting over the bridge and merging in the welding chamber for a hollow extrudate, front end formation, curling or twisting of the entire extrudate, and complete load vs. stroke behavior. Parallel computing can speed up updated Lagrangian simulations. The steady state Eulerian approach, in which the mesh is fixed in space, is fast but can not provide any transient information and the thermal-mechanical stationarity may not be well established in reality [2].

* Corresponding author's.e-mail: sassa@masfak.ni.ac.rs

The Arbitrary Lagrangian Eulerian (ALE) approach stands as a hybrid method that bridges the gap between Eulerian and Lagrangian formulations. It holds particular efficiency for a specific class of problems due to its unique characteristics, as highlighted in references [3] and [4]. Unlike the updated Lagrangian method, the ALE approach reduces the need for frequent remeshing, enhancing computational efficiency significantly. Moreover, it addresses some limitations inherent in the steady-state approach by employing an incremental procedure, offering advantages for problem-solving [4].

The ALE method represents an endeavor to amalgamate the strengths of both Eulerian and Lagrangian formulations. Initially introduced by Hirt et al. and subsequently refined by Donea et al., it found its inception in modeling solid-fluid interactions. Over time, its application extended to addressing problems in solid mechanics involving substantial deformations [5, 6]. This method has proven to be instrumental in handling scenarios where the interaction between solids and fluids or large deformation mechanics poses challenges for traditional modeling approaches.

2. FEM ANALYSIS OF FORWARD EXTRUSION PROCESS HOLLOW ELEMENTS

In the general ALE method, two mesh systems are employed: the computational reference mesh system for finite element calculations and the material reference mesh system that tracks material deformations. The relationship between these systems in the Lagrangian, Eulerian, and ALE descriptions relies on node positions at the end of a time iteration. At the onset of a new ALE step, the material reference mesh system aligns with the computational reference mesh system. In the Lagrangian formulation, nodes move with the material throughout a time increment, while in the Eulerian formulation, nodes remain fixed in space [4, 5]. The ALE method offers flexibility by enabling tailored adjustments to the new positions of computational reference mesh nodes, based on specific simulation requirements (Fig. 1).

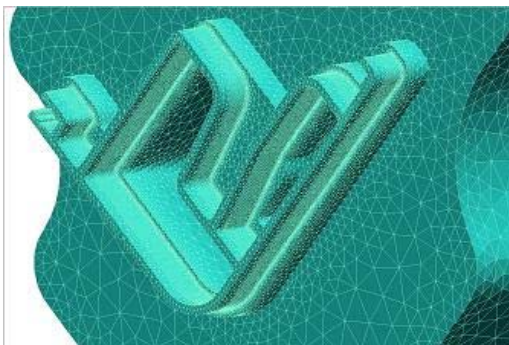

Fig. 1. FEM model of finished part at the end of process (www.qform.com)

In the ALE formulation, both material reference mesh system and computational reference mesh system consist of hexahedral, tetrahedral (volumetric problems) or

triangle elements (plane problems) that are moving in the extrusion direction. The movement of the computational reference mesh system differs in the three or two directions [5,6]. The nodes are fixed in the extrusion direction, while they are updated in a Lagrangian fashion in the plane perpendicular to the extruding direction. To implement this, the computational reference mesh system is superimposed with the material reference mesh system at the beginning of the simulation. The increment proceeds exactly as that for the pure Lagrangian description using the computational reference mesh system through the end of the solution phase [4, 5]. As the computational mesh deforms and changes its geometry, new coordinates and deformation state variables are obtained during the simulation and then are transferred to the material reference mesh system at the end of each increment to update it. The computational reference mesh system remains unchanged at this stage. Since the initial nodes and elements of the computational mesh belong to the material mesh, no interpolation of the state variables is needed. Instead, nodal and elemental values are simply registered to the material mesh [5, 6].

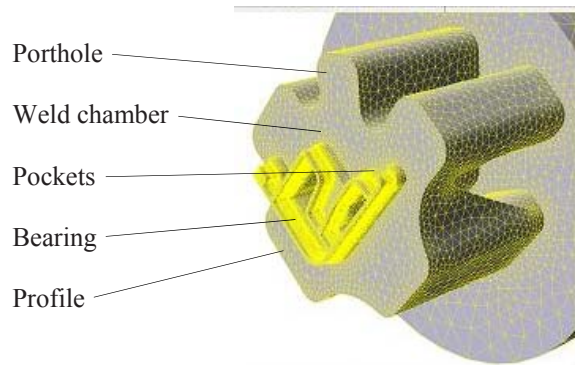

Fig. 2. Deformable metal volume inside of tool (www.qform.com)

The subject of the analysis are hollow and semi-hollow aluminum elements, and therefore, this tool model implies the existence of a mandrel, which ensures obtaining a profile with the given internal shape and dimensions (Fig. 2).

On the example of extruding a pipe (5) with a circular cross-section (Fig. 3) on a partial section, the parts of the tool in direct contact with the deformable aluminum material (2) can be recognized [7,8]. Due to the axial movement of the tool ram (1) and the high pressure in contact with the deformable material, it first encounters four bridges (6) that separate the deformable material into eight parts filling the chambers (7) that direct the material around the mandrel (3) to the die matrix (4) which forms the exit section with the bearing length (9). Its length defines, on the one hand, the quality and accuracy of the finished part, but also the quality of the tool itself and its working life [8, 9].

The arrangement of the bridges and the configuration of the tools are dictated by the geometry of the finished part. In most cases, these are cylindrical billet (2) which at elevated temperatures (for aluminum $t \approx 450^{\circ}\text{C}$) flow around the

bridges (6) and one or more mandrels (3) of the tool into complex cylindrical or prismatic profiles (5) with smaller or larger deviations from regular geometric shapes [8, 9]. For the mechanical model itself, it is assumed that in the exit zone of the tool, in different axial sections, it is a plane deformation state. Such a model is imposed as a solution, because in the majority of cases, the output profile has a very small wall thickness, around 1mm, and a significantly larger width on the circumference.

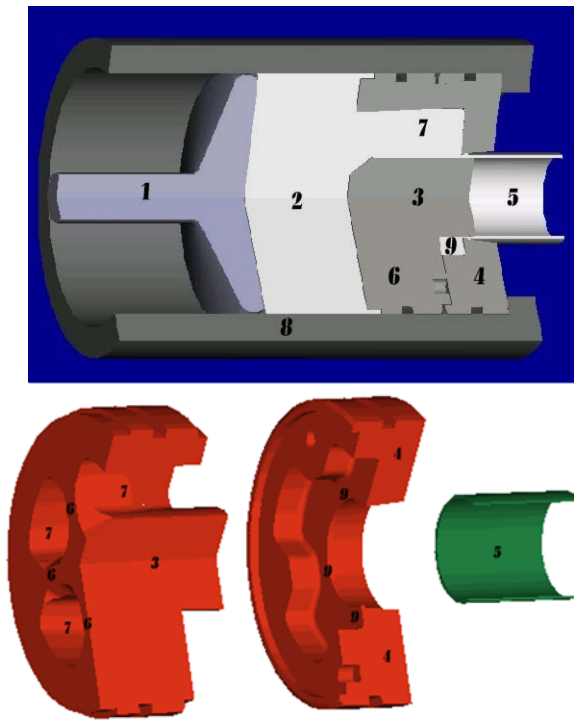

Fig. 3. Partial section of deformable aluminum volume inside of tool

For this analysis, a finite element with the name Element 11 (MSC.Marc), an arbitrary square element, with four nodes, which is recommended for the plane deformation state, was used. Nodes are marked counter-clockwise [11]

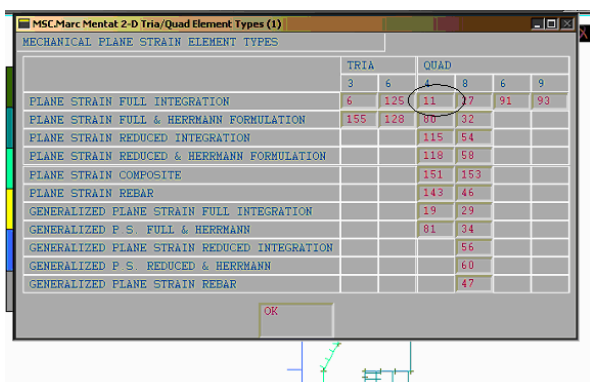

Fig. 4. Selection of the FEM elements

Its complete geometry is defined by twelve nodes. If any of the nodes on the page of the element is not defined, it retains its initial straight line shape, without nodes. A quadratic element is created by mapping the unit square

with a third-order polynomial. For these reasons, it can be used to approximate curved boundary surfaces. As this element uses a bilinear interpolation function, the deformations on its surface tend to be equal. For these reasons, this element is not favorable for the discretization of continuums loaded in shear and bending. This behavior can be corrected to some extent by using alternative interpolation functions [11].

The stiffness of this element is formed via four Gaussian points inside the element. It can be used for all types of constitutive relations.

The ability to adapt the behavior of the network, in this solution, implies an increase in the number of elements, of the same type, by dividing the original element by its interior at a certain level (four new ones are obtained from one existing one) [11].

Each adaptive process takes place according to a precisely determined and chosen iterative criterion until its fulfillment in each step. Also, the remeshing of the deformed network is performed according to one, two, three or all four criteria set in advance. These are the criteria of element distortion, contact penetration, incremental and angular deviation [8, 9].

For adaptive models, there are three sources of nonlinearity in the plastic deformation processes of metals, the nonlinear behavior of the continuum itself, the nonlinear geometry, and the nonlinear boundary conditions. Non-linearity of the material comes as a result of nonlinear connections between stress and strain in the area of plasticity, as well as the strengthening effect present during the deformation process [4,6,13].

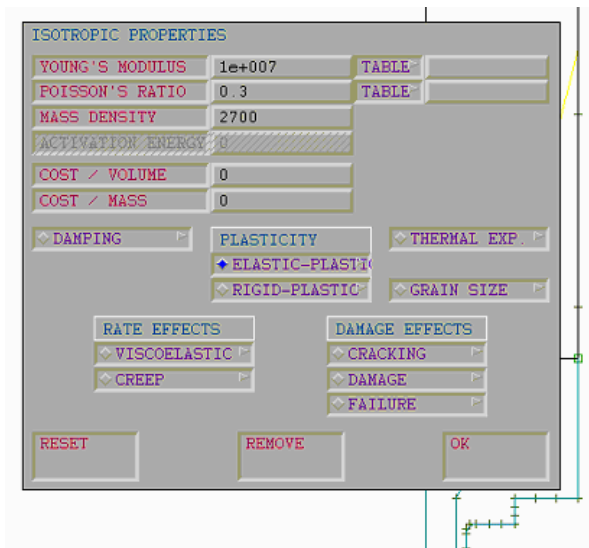

Fig. 5. Mechanical characteristic aluminium alloy

The model of the billet itself has the characteristics of aluminum with recognizable physical parameters (Fig. 6) and the law of hardening which is given through the diagram (Fig. 7) [10].

Geometric nonlinearity refers to the relationship between strain and displacement, that is, to the relationship between stress and deformation force [11].

The nonlinearity of the boundary conditions refers to contact stresses and changes in the friction force during the deformation process [4, 11].

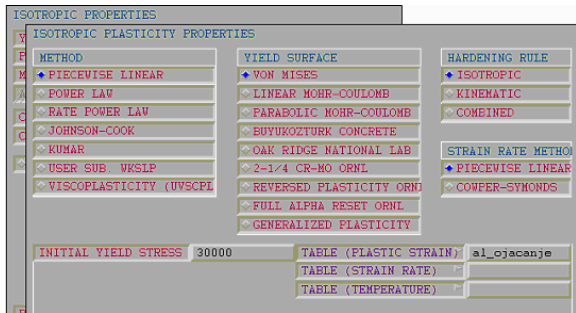

Fig. 6. Input plastic parameters

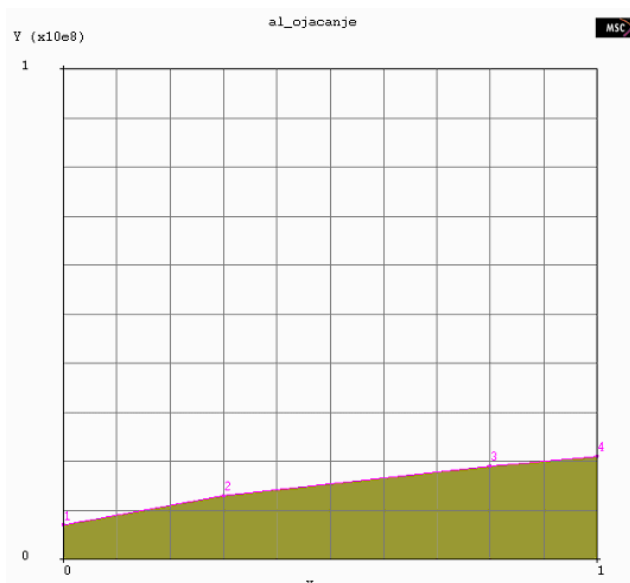

Fig. 7. Curve of aluminium hardening

On the generated plane model of the longitudinal section, a two-dimensional model of the billet whose plasticity parameters are monitored during the process of filling the mold cavity and forward extruding it into the calibration zone of the tool can be recognized, the model of the rigid matrix, which here plays the role primarily of limiting the space in which the simulation is monitored and the mandrel model that conditions the obtaining of hollow aluminum elements (Fig. 8) [12].

For the billet volume, a relative movement along the y-axis with a negative sign and a sufficient number of finite elements (336) was assigned to fill the entire mold cavity and extrude into the calibration zone. The size of the square element was varied at two levels of 0.04 and 0.05, thus creating a balance between two opposite requirements, the fineness of the simulation and its duration [12]. The criterion for remeshing the network is defined by the frequency of increase 5 (Fig. 8).

Numerous tests and analyses of existing solutions suggest that it's optimal to delineate the load into two intervals. Initially, a smaller interval is ideal for the establishment

and commencement of the plastic flow process. Subsequently, a larger interval is considered, encompassing the entirety of the analysis until the simulation's conclusion. Due to these considerations, both the first and second load periods are configured during the plastic deformation process. The number of steps set, which determines the total duration of the load, significantly influences the number of iterations required for simulating the entire plastic deformation process (Fig.9). Given these factors, considerable attention and numerous experimental trials have been dedicated to addressing this issue, aiming to achieve the most precise and authentic solution possible [12, 14, 15].

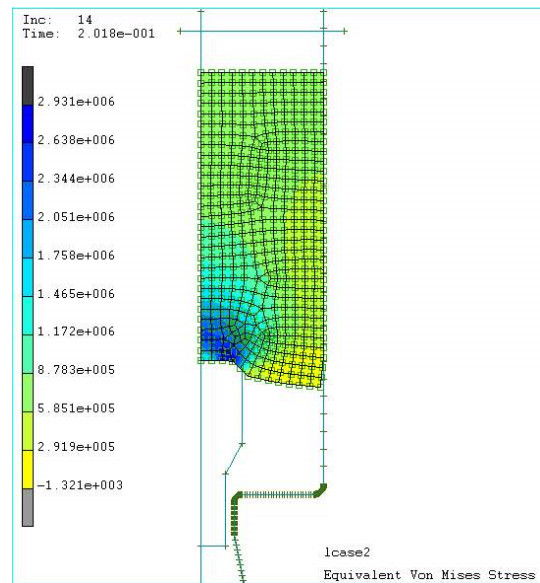

Fig. 8. FEM adaptive model of stress distribution in y direction, increment 14

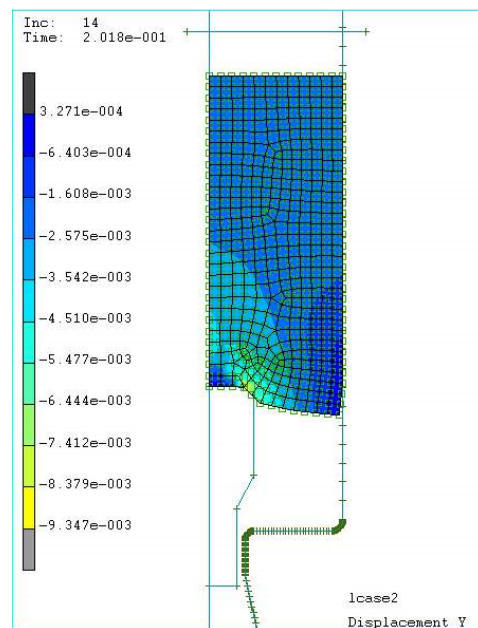

Fig. 9. FEM adaptive model of displacement distribution in y direction, increment 14

Examining the stress distribution near the tool's surface at the bottom and the entry to the exit profile through the nodes of the finite element mesh helps assess the continuity of the stress field [15]. This analysis is crucial to prevent extension stresses that could lead to failure in the aluminum alloy's material structure. Specifically, it helps avoid discontinuities in the plastic flow right before the exit profile, which could potentially transfer into the wall of the extruded element (Fig. 10). Understanding and managing these stress patterns are crucial in ensuring the structural integrity and quality of the final extruded product.

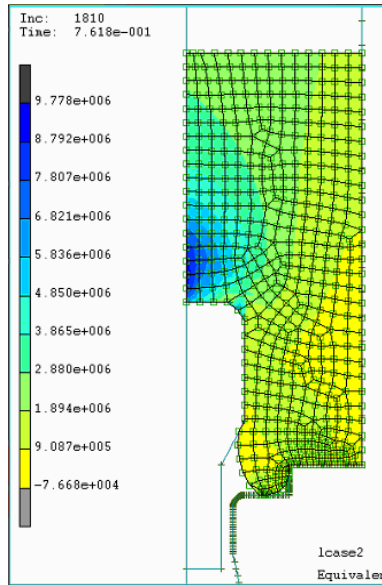

Fig. 10. FEM adaptive model of the stress distribution in the area of plastic deformation, increment 1810

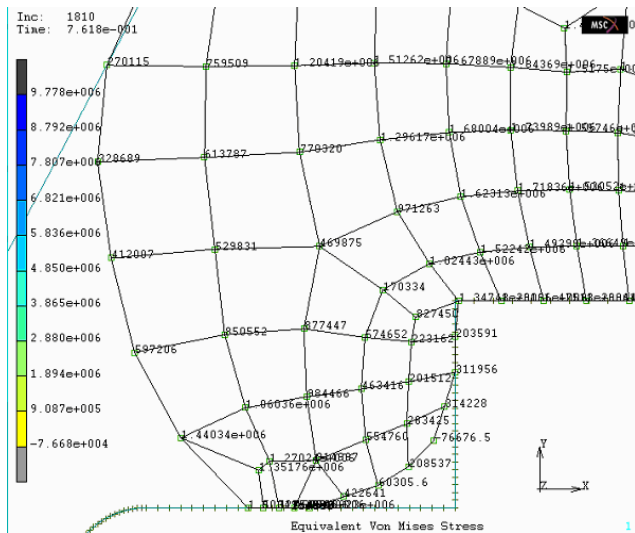

Figure 11. Value of the stress in the nodes of FEM mesh, increment 1810

Once the number and duration of various loads are determined, conditions and criteria for the plane deformation state are established. An updated Lagrange procedure was selected, configuring a maximum number of segments, specifically 2000 nodes in contact.

Additionally, the simulation allows the selection of output results that can be monitored at the conclusion of the process (Fig. 11).

The simulation of the plastic deformation process itself provides outstanding opportunities for detailed monitoring and analysis of results in the focus of deformation under different geometric conditions. Here, the case of unidirectional extrusion of hollow elements is analyzed when the mandrel face is flat in order to reduce the load on the tool bridge and improve the uniformity of extrusion of aluminum in the tool cavities before entering the calibration zone (Fig. 12). In order to reduce the dead zones, different structural transitions are performed on real tools, which, with their shape and number, improve the entry of aluminum into the calibration zone. Their number and size are the subject of many researches, while this paper presents only one example and the simulation of plastic deformation in their vicinity.

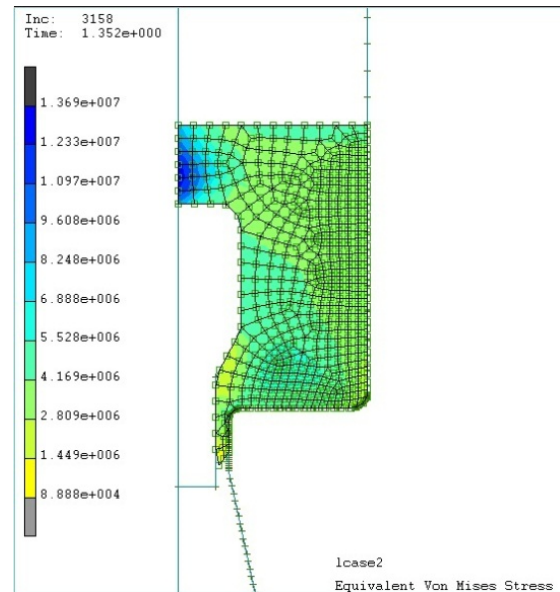

Fig. 12. The equivalent stress at the moment of exit die orifice, increment 3158

5. CONCLUSIONS

The objective of the numerical analysis in the forward extrusion process is to create a simulation model capable of highlighting issues that might only become apparent in the final product. Through iterations that adjust the dimensions and angles of the tool on the geometric model, a viable tooling solution is achieved. This results in a finished part that meets the specified dimensions and surface quality criteria. Monitoring the stress-deformation field during plastic deformation helps prevent structural material failures, ensuring the production of a flawless final product, devoid of hidden errors.

Among these tools, modifying the working length and making slight volume corrections stands out as the parameter that effectively resolves a majority of issues in the process.

REFERENCE

- [1] Belytschko, F., Liu, W. K., Moran, B. (2000). *Nonlinear Finite Elements for Continuous and Structures*, John Wiley & Sons, New York.
- [2] Chen, F. K., Chuang, W. C., Torng, S. (2008). Finite element analysis of multi-hole extrusion of aluminum-alloy tubes, *J. Mater. Process. Technol.*, 201, pp. 150–155.
- [3] Rodriguez-Feran, A., Casadei, F. M., Huerta, A. (1998). ALE stress update for transient and quasistatic, *International Journal for Numerical Methods in Engineering*, 1.41:241-262.
- [4] Flitta I., Sheppard, T. (2003). Nature of friction in extrusion process and its effect on material flow, *Materials Science and Technology*, vol. 19. No. 5, pp. 837-846.
- [5] Donati, L., Reggiani, B., Pelaccia, R., Negozio, M., Di Donato, S. (2022). Advancements in extrusion and drawing: a review of the contributes by the ESAFORM community, *J. of Mater. Form.*, pp. 40-68.
- [6] Duan, X., Sheppard, T. (2003). Computation of substructural strengthening by the integration of metallurgical models into the finite element code, *Computational Materials Science*, vol. 27. pp. 250-258.
- [7] Duan, X., Sheppard, T. Sheppard. (2003). Simulation and control of microstructure evolution during hot extrusion aluminium alloys, *Materials Science and Engineering*, vol. A351, pp. 282-292.
- [8] Poletti, C., Sherstnev, P., Schöbel, M. Sommitsch, C. (2008). Substructure development of AA6082 during hot deformation, *Aluminium Alloys, Their Physical and Mechanical Properties*, J. Hirsch et al. (Eds.), DGM, Wiley-VCH, vol.1, pp. 691-697.
- [9] Krumphals, F., Flitta, I., Mitsche, S., Wlanis, T., Jahn, A., Sommitsch, C. (2008). Comparison of experimental and Finite Element Modelling of the extrusion of AA6082 on both tools and extrudate as a function of process parameters. *Int. J. Mater. Form.*, 1: pp. 427–430. <https://doi.org/10.1007/s12289-008-0086-0>
- [10] Roters, F., Raabe, D. Gottstein, G. (2000). Work hardening in heterogeneous Al-alloys – A microstructural approach based on three internal state variables, *Acta Materialia*, vol. 48. pp. 4181-4189.
- [11] MSC. Marc, (2000). vol. B Element library, MSC Software, Simulating reality, Los Angeles, CA, U.S.A.
- [12] Randelović, S. (2006). Modeling of the process of forward extrusion of hollow elements ensuring high process capability, University of Niš, Faculty of Mechanical Engineering, Doctoral Dissertation, pp.149, Niš,
- [13] Zhang, C., Dong, Y., Zhao, G., Chen, L. (2017). Experimental and numerical investigation on transverse weld of hollow aluminum profile during porthole extrusion process. *Procedia Eng.*, 207, 1653–1658.
- [14] Valberg, H., Misiólek, W. (2006). Plastic deformation in hot extrusion of an aluminum alloy characterised by FEM-analysis with experiment. In: *The 9th International Conference on Material Forming ESAFORM*, 1: pp. 587–590.
- [15] Schikorra, M. Tekkaya, A. E., Donati, L. Tomesani, L. (2008). Effect of Pocket Shape in the Extrusion of Aluminium Profiles”, *Aluminium Alloys, Their Physical and Mechanical Properties*, Hirsch, J, Skrotzki, B, Gottstein, G, (eds.), Vol. 1, pp. 1387-1393.